



HF/50MHz TRANSCEIVER

# IC-7800

# THE MASTERPIECE

**RF Technical Excellence and  
Craftsmanship Unparalleled.**



Icom Inc.

# From 40 years of RF design expertise comes the Masterpiece Ham Radio Transceiver

Icom is a pioneer in the amateur radio world. Starting with the first analog PLL circuit in the IC-200 to the ground-breaking 32-bit DSP technology used in the IC-756PRO, Icom's developed some of the most innovative radio equipment ever made. Continuing with this tradition, Icom announces the ground-breaking IC-7800!

The IC-7800's somewhat familiar looks will remind many HF operators of the IC-781. The IC-781 set benchmarks back in the 1980's as that generation's ultimate HF transceiver. Some of today's operators still feel the IC-781 is the pinnacle in amateur radio design. They have not seen the IC-7800. It takes amateur radio to a whole new level of performance. The IC-7800 will be viewed as the pinnacle radio for years to come.

The IC-7800 is an artistic fusion of over 40 years analog RF circuit development expertise and cutting-edge digital technology. The result is TWO identical receivers with 110dB dynamic range, +40dBm 3rd order intercept point, and unmatched DSP technology in the HF bands something that has never been achieved in Ham radio!

Simply put, Icom has developed the ultimate Amateur HF transceiver. No one else comes close!

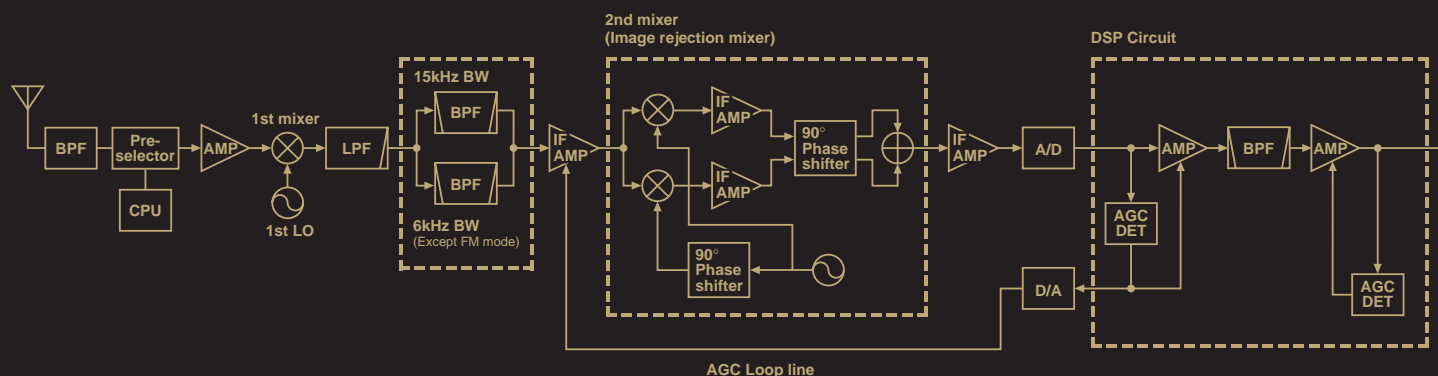

## +40dBm IP3 (3rd order Intercept Point)

Icom's considerable analog RF circuit experience combined with cutting-edge digital technology results in an astonishing 110dB receiver dynamic range and a +40dBm IP3 in the HF bands. A first in Ham radio! To achieve this superior receiver performance, Icom's engineering team completely re-engineered the whole analog circuit and matched it to the DSP units. This allowed us to explore new technical dimensions.

### Dynamic range characteristics (in 14MHz band)

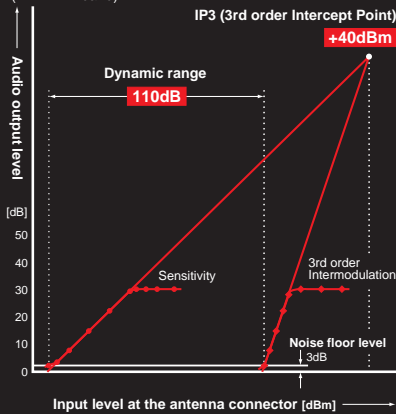

rived from out of band interference such as multi-multi operation or strong broadcast stations. It automatically tracks the intended signal keeping the pre-selector's bandwidth centered on the operating frequency. The center frequency of the pre-selector is manually adjustable from the DIGI-SEL tuning knob on the front panel.



DIGI-SEL unit

### DIGI-SEL Characteristics in the 14MHz band

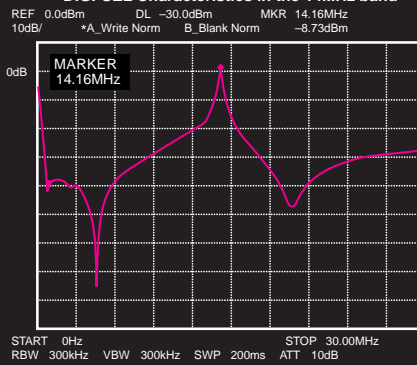

## Internal distortion reduction

The IC-7800 uses durable mechanical relays for BPF switching instead of non-linear semi-conductors, like switching diodes which can cause distortion. The mechanical relay reduces secondary distortion at the primary stage of signal processing.

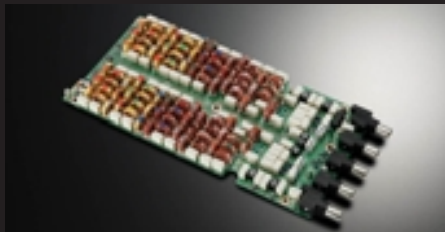

BPF unit

## Improved blocking

Contesters know how frustrating it is to experience a strong adjacent signal that's blocking the receiver from pulling out a weaker signal. Before the 1st amplifier, the IC-7800's two roofing filters block strong adjacent signals. You can select the filter widths from 15kHz and 6kHz, depending on operating mode. (FM mode is fixed to 15kHz.)



Two roofing filters

## Icom's DIGI-SEL

The pre-selector works between 1.5MHz and 30MHz and rejects distortion components de-

Simple receiver system configuration is the best way to eliminate sources of the spurious signals and distortion from transceivers. The IC-7800 uses a double conversion system composed of a D-MOS FET 1st mixer and a newly developed image rejection mixer for the 2nd stage. The 1st mixer stage is driven with a signal from the high-drive Local Oscillator with excellent C/N. The image rejection mixer for the 2nd stage reduces signal distortion through IF processing and provides a high-fidelity signal to the DSP unit. This system provides wide dynamic range, reducing the distortion from strong signals and lower intermodulation.

## Less internal phase noise

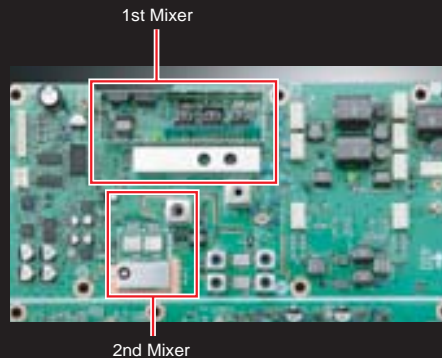

## Multiple AGC loops

The IC-7800 has multiple AGC loops. The AGC voltages detected in front of and behind the digital IF filter in the DSP unit. The first AGC loop

prevents saturation of the 1st IF amplifier. The other AGC loop detects the AGC voltage at the digital IF filter output which has only passed the intended signal and draws the full potential from the digital IF filter. Combining the digital IF filter, manual notch, and the 1st IF stage, these are all controlled by the DSP unit. 110dB of ultra wide dynamic range in the receiver means the IF amplifier is distortion free from strong signals.

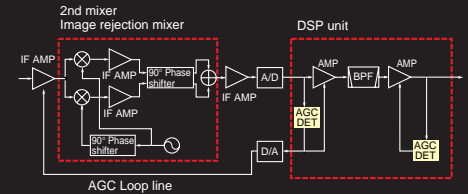

## Full AGC controls

The IC-7800 accommodates both the "on-the-fly" operator as well as the most avid "tweaker" operator by providing tunable AGC preset and manual AGC level controls. The AGC time constants can be set in the 3 presets (slow, medium and fast), adjustable from 0.1–6 sec. (0.3–8 sec. at AM) delay. Then the addition of the AGC VR control enables the user to "tweak" or fine tune the AGC reaction time.

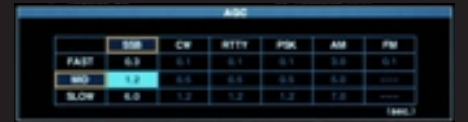

AGC setting screen

## Digital IF filter

The IC-7800 incorporates the "build your own" filter. This allows the operator to adjust filter shaping (sharp or soft), filter bandwidth, and center frequency characteristics, without missing the action. Multiple filter memories store the last used filter settings by using operation mode. This allows the operator to quickly switch filters for constant operating conditions, such as in a contest. Icom's digital IF filters give you performance that is not possible with crystal or mechanical filters.



Filter preset screen.

## Digital twin PBT (Passband Tuning)

Once the IF filters have been "tweaked", the operator has additional control with the digital twin PassBand Tuning (PBT). The digital twin PBT allows flexibility of both the IF shift and narrowing of the digital IF passband by moving the IF passband. With the digital IF filters, PBT performance allows you to cut away all the interference and noise to hear the actual signal.

In addition to the filter preset menu, the LCD indicates the twin PBT conditions across the top of the screen, so you can still use the lower portion of the TFT display for other radio operations.

### Digital manual notch filter

In recent years, HF operators have marveled at how well DSP reduces interfering signals and noise. Signals such as heterodynes and AM Carriers can be eliminated with Automatic Notch filter technology. Making interference from RF sources such as beat signals and RTTY signals is a thing of the past. Additionally, the filter shape of the Manual Notch can be adjusted in three steps, with more than 70dB of attenuation!

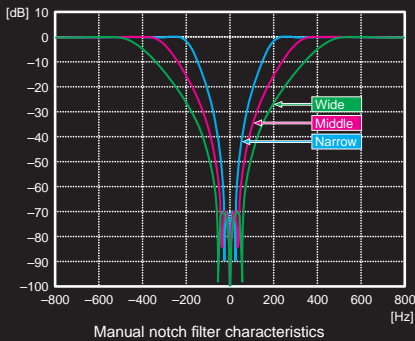

### Variable level noise reduction

The 32-bit DSP processing power of the IC-7800 produces real results by separating a signal component from the noise with the variable noise reduction. By suppressing the noise components, an outstanding signal-to-noise ratio is achieved, providing clean, clear audio in all modes without distortion of the target signal.

### Adjustable noise blanker

A newly designed, digital noise blanker significantly reduces pulse type noise. As part of the 32-bit DSP function, there are three adjustments: threshold level, blank time parameter, and attenuation level.

### 50MHz band preamplifier and mixer

The IC-7800 was designed with the 6m aficionado in mind. Rather than sharing circuits used for HF, a separate preamplifier and mixer was designed especially for 6m. This greatly improves the receiver sensitivity by reducing inter-

modulation characteristics, enabling weak signal work without distortion or interference from strong signals in the band.

### Quad processing

The IC-7800 incorporates four independent, 32-bit floating DSP units and 24-bit AD/DA converters. By having four independent DSP units, the radio will respond to operator changes in an instant, as each DSP unit has a dedicated function. While there is one for each receiver, this includes the AGC and Filter controls, there is a DSP unit for transmit as well as a DSP unit for the Spectrum Scope.



DSP Unit

### Two completely independent receiver circuits

The IC-7800 incorporates two completely independent receivers, from the antenna inputs all



the way though to the stereo headphone or individual external speaker outputs. All the performance of the first receiver is duplicated for a perfectly matched set of "Twins". When connected to external stereo headphone, main and sub receiver audio can be mixed or separated to right and left.

### Real time spectrum scope

With its introduction in the IC-781, having a spectrum scope in an HF radio changed the way HF operators "see" the band! Due to the DSP unit for the scope, the IC-7800's spectrum scope provides excellent sensitivity, with 80dB of dynamic range. While the scope rivals many of today's commercial test sets, there are 7 steps, ranging from  $\pm 2.5$  to  $\pm 250$ kHz. This is up to 500kHz of spectrum!

Also, there is a setting to allow for specific scope edges or center the span on the receiving frequency. In addition to these features, the scope has 3 levels of attenuator (10dB, 20dB, 30dB), 3 types of reference markers (main receiver, sub receiver, transmit), 3 levels of sweep speed (slow, mid, fast), peak hold and main/sub band one touch switch.

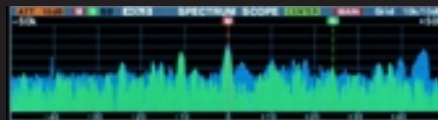

Example of spectrum scope centered on the receiving frequency.



Example of fixed spectrum scope range.



Mini scope screen.

### Ultra high stability OCXO unit

The IC-7800 uses the OCXO (Oven Control Crystal Oscillator) unit which is stable to within  $\pm 0.05$ ppm

at 0°C to 50°C. This specification means that even on the 50MHz band, frequency error is less than 2.5Hz! In addition, a 10MHz reference frequency can be input and output for accurate tuning.



OCXO Unit

### Central Control

In the heat of a big contest or a DX-pedition, control placement is extremely important as every second counts. So Icom took a proven system, the IC-781, and used the basic front panel design for the IC-7800, incorporating improvements for all the new features and controls. Often used functions, including RF power and key speed have independent large knobs for easy access. The "XFC" button is placed efficiently for holding the button by the left hand, and moving the main dial with the right hand.



The above photo shows actual size.

## 7-inch wide color TFT LCD

While Icom's RF engineering team reviewed receiver designs for how the IC-7800 hears a signal, close attention was also paid to how the operator sees a signal. Details such as response time, color, resolution, and visibility were extremely important. Thus, an active matrix 7-inch (800x400 pixel) TFT color display was selected for the IC-7800.

This large display shows main, sub-band frequencies, including various settings, and operating conditions, as well as the spectrum scope, S-meter, and RTTY/PSK31 decoded messages. The "virtual" S-meter shows high quality, analog-looking needle swings that are smooth and accurate. In addition to the 3 styles of "virtual" meters, the IC-7800 has digital multi-function bar graphic meters to show various conditions, including transmitter PA temperature and voltage. If a larger display is desired, the IC-7800 has a VGA connector for an external monitor and an S-meter connector for an external analog S-meter.



Bar type meter

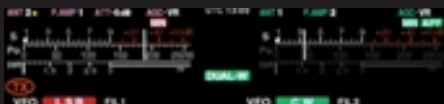

Edge width meter



Multi-function meter

Memory	Freq	Mode	Filter	Bandwidth
1	14.215.000	CW	FL2	140 DSKSPOT
2	3.000.000	CW	FL2	800 DSKSPOT
3	3.718.000	CW	FL1	700 DSKSPOT
4	7.000.000	CW	FL2	400 DSKSPOT
5	7.000.000	LSB	FL1	400 DSKSPOT
6	14.120.000	CW	FL2	200 DSKSPOT
7	14.020.000	CW	FL2	200 DSKSPOT
8	14.100.000	USB	FL1	200 DSKSPOT
9	14.100.000	USB	FL1	170 DSKSPOT
10	14.140.000	USB	FL1	170 DSKSPOT
11	14.140.000	USB	FL1	170 DSKSPOT
12	21.020.000	CW	FL2	100 DSKSPOT
13	21.020.000	RTTY	FL1	100 DSKSPOT
14	21.250.000	USB	FL1	100 DSKSPOT
15	21.850.000	CW	FL2	120 DSKSPOT
16	21.850.000	CW	FL2	120 DSKSPOT

Memory list screen (Wide setting)

## RTTY/PSK31 operation without PC connection

Another amateur radio first is the capability of receiving and transmitting RTTY and PSK31 without the aid of a computer. While decoded RTTY and PSK31 is shown on the 7-inch display, simply connect a USB keyboard to the IC-7800 to send as well. To reduce errors in receiving RTTY, the IC-7800 has a digital twin peak filter to reduce interference from other signals in the band. Also, transmitted and received messages can be stored to a CF memory card, which may then be transferred to your PC.

In addition, a total 8 channels of RTTY and PSK31 transmit memory stores up to 70 characters of often used messages for each channel.



RTTY decode screen

## 200W output power at full duty cycle

The newly designed push-pull power amplifiers using power MOS-FETs work on 48V DC. They provide a powerful 200W output power at full duty cycle and low transmit intermodulation. An effective cooling system maintains internal temperatures within a safe range and prevents thermal runaway.



PA unit and heat sink



PA unit (close up)

## Microphone equalizer

One of the four 32-Bit DSP units is used for adjusting the transmit audio. Digitally tweak your transmit audio with the separate bass and treble controls for incredible sounding audio. This built-in audio equalizer has a total of 121 combinations for each phone mode, so you can master the warm, full audio you want. In addition to the equalizer, a new parametric transmit bandwidth for the SSB mode allows the operator to set both the high- and low-pass filter limits. (100, 300, 500 for the high-pass and 2.5, 2.7, and 2.9 kHz for the low-pass). Then store the filter settings into the three bandwidth memories. The operator may now go from DX to rag chew audio with the push of a button.



Transmit bandwidth setting

## RF speech compressor

The IC-7800 utilizes the 32-bit DSP for the RF speech compressor providing the maximum punch without the fuzzy sound. It's great for breaking through the noise and hash to complete the QSO.

## CF memory card

Making big scores means keeping your team fresh on those long DX-peditions or Multi Op contests. Swapping out operators usually involves time-wasting radio tweaks, because each operator has their own favorite settings to best

match their operating style. This all changes with the CF memory card! Prior to a contest, operators may record their preferred IC-7800 settings such as filter, Digital Voice Recorder (DVR) memories, antenna settings, etc. When it's their turn to operate, simply insert their CF card into the IC-7800. In a flash, the '7800 is now "their rig", and there's nearly zero down time!

## Digital voice recorder

The IC-7800's Digital Voice Recorder (DVR) is a very convenient function for contests, DX-peditions, and even normal operation. Record your callsign, CQ, or contest number in up to four memory locations. A total of 90 seconds is available for the four memories, with each memory channel being soft partitioned to allow custom recording sizes.

The front panel control of the DVR allows you to record incoming signals up to 200 seconds for 20 channels (Max. 30 sec. per channel). The playback automatically mutes the receiver for clear playback of the previous 15 seconds of recorded audio. It's the perfect feature for those contest operators wanting to improve their UBN reports.

## Digital IF data filter

For the AFSK operators, the IC-7800 automatically adjusts its digital IF filters for optimum settings. When the digital IF filters are adjusted to 500Hz or less in SSB or SSB-D, the sharp CW bandpass filter (BPF) is selected and the 1/4 tuning step is selected.

## 4 antenna connectors

For the ultimate in antenna control, the IC-7800 has 4 antenna connectors with a programmable automatic antenna selector. Each antenna connector can be customized to the antenna usage type, such as a beam for TX and a beverage antenna for RX, as well as to specific antenna/band configurations.

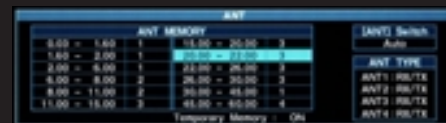

Antenna memory setting screen

## Complete CW features

All of the following CW capabilities are included in the IC-7800:

- DSP controlled CW keying waveform shaping
- Multi-function electronic keyer with adjustable keying speed from 6–60 wpm, dot-dash ratio from 1:1:2.8 to 1:1:4.5 and paddle polarity
- CW pitch control from 300 to 900Hz
- CW-Reverse mode operation with selectable normal (default) carrier point
- Double key jack system (front and rear panel)
- Full break-in and semi-break-in functions
- CW/AM auto tuning function helps to zero in on intended signals within  $\pm 500$ Hz range
- 4 channels of memory keyer with 70 characters of transmit memory
- Bug keyer and microphone up/down keyer

## Other outstanding features

### [Antenna line]

- High speed automatic antenna tuner covers HF and 50MHz bands.
- BNC type Rx In/Out connectors for receiver antenna or external attenuator, etc.

### [Receiver]

- General coverage receiver covers from 30kHz to 60MHz (\* Some frequency bands are not guaranteed. Depending on version.)
- Two types of receive preamplifiers:  
Preamp 1; Increase low level signal improving intermodulation characteristics  
Preamp 2; High gain preamplifier
- Built-in receive audio equalizer tweaks receive audio with the separate bass and treble controls
- 7-step attenuator (3, 6, 9, 12, 18, 21dB and OFF)
- External speaker connectors for main and sub receiver

### [Transmitter]

- Tx monitor
- 50 CTCSS tone encoder and decoder
- VOX capability (Voice operated transmission)
- All mode power control

### [Operation]

- Set mode function for flexible and speedy setting
- Memory pad stores up to 5 or 10 operating frequencies
- Quick split function and frequency lock function for split operation
- Triple band stacking register
- SSB/CW synchronous tuning
- Single knob control from squelch to RF gain
- RIT and  $\Delta$ Tx variable up to 9.999kHz
- 1Hz pitch tuning and indication
- 101 memory channels with 10-character alphanumeric
- Auto tuning step function

- Built-in voice synthesizer announces operating frequency, mode and receiving signal strength.
- Programmed scan, memory scan, select memory scan, VSC scan and  $\Delta$ F scan
- Main dial tension control
- CI-V interface capability
- Optical digital audio input/output for PC connection
- BNC type Transverter connector  
Offset frequency is user programmable and actual frequency is displayed.
- UTC/Local Clock and timer function

### Supplied accessories:

- CF memory card (64MB)
- AC power cable
- Spare fuses
- Speaker plugs
- Key plug
- ACC plugs
- Power plug
- Pin plug
- Rack mount handles

## Rear panel view

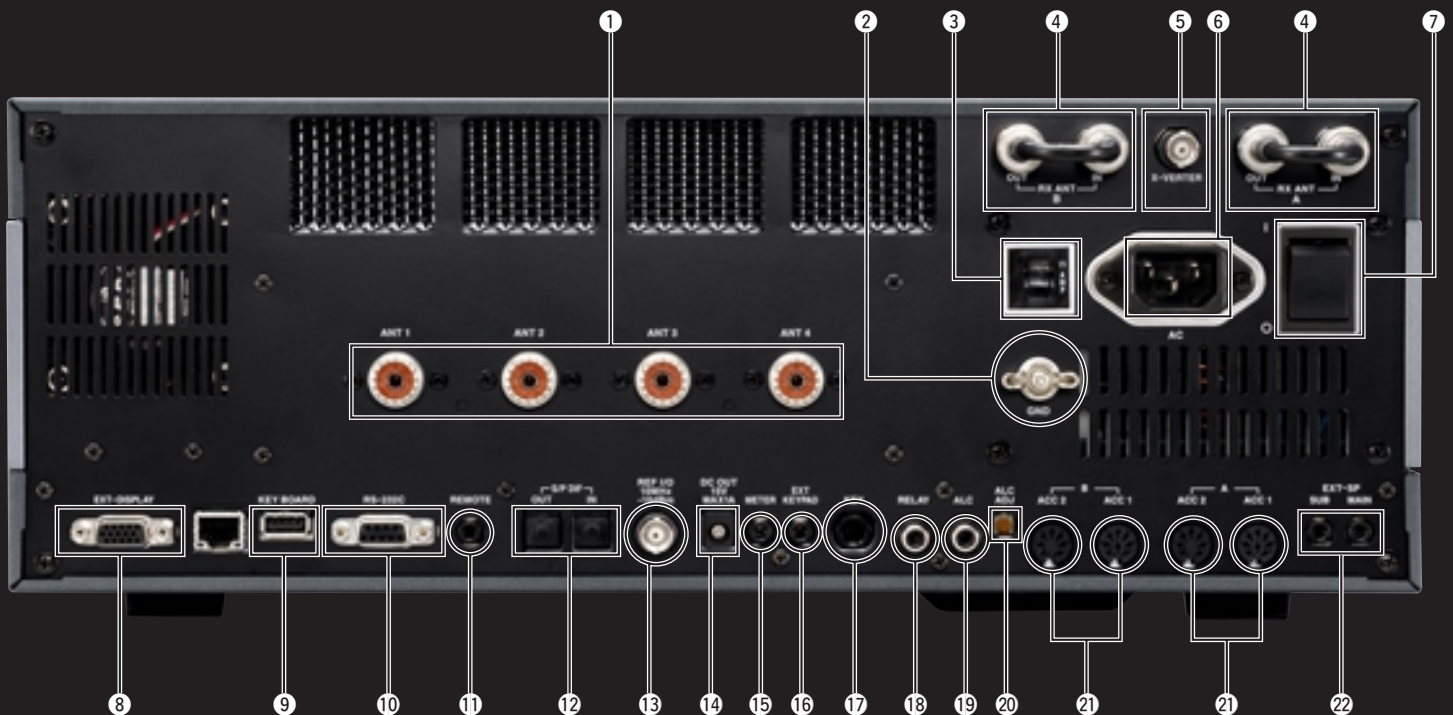

① Antenna Connectors

② Ground Terminal

③ Breaker Switch

④ Receive Antenna Connectors A/B

⑤ Transverter Jack

⑥ AC Power Cord Receptacle

⑦ Main Switch

⑧ External Display Connector (VGA)

⑨ USB Keyboard Connector

⑩ RS-232C Connector

⑪ CI-V Remote Control Jack

⑫ S/P DIF In/Out Jacks

⑬ Reference Frequency In/Out Jack

⑭ External DC Output Jack

⑮ S-meter Output Jack

⑯ External Memory Keypad Jack

⑰ Key Jack

⑱ Tx/Rx Control Jack (Relay)

⑲ ALC Input Jack

⑳ ALC Level Pot

㉑ ACC Sockets A/B

㉒ External Speaker Jacks

## SPECIFICATIONS

### GENERAL

- Frequency coverage\*1 :  
U.S.A. Version  
Rx 0.030–60.000MHz\*2  
Tx 1.800–1.999MHz\*2 3.500–3.999MHz  
5.3305, 5.3465, 5.3665, 5.3715, 5.4035MHz\*3  
7.000–7.300MHz 10.100–10.150MHz  
14.000–14.350MHz 18.068–18.168MHz  
21.000–21.450MHz 24.890–24.499MHz  
28.000–29.700MHz 50.000–54.000MHz

#### Europe Version

- Rx 0.030–60.000MHz\*2  
Tx 0.1357–0.1378MHz 1.800–1.999MHz  
3.400–4.099MHz\*2 6.900–7.499MHz\*2  
9.900–10.499MHz\*2 13.900–14.499MHz\*2  
17.900–18.499MHz\*2 20.900–21.499MHz\*2  
24.400–25.099MHz\*2 28.000–29.999MHz\*2  
50.000–54.000MHz\*2

\*1 Frequency ranges vary depending on version.

\*2 Some frequency ranges are not guaranteed.

\*3 Carrier point frequency.

- Mode : USB, LSB, CW, RTTY, PSK31, AM, FM
- Number of channels : 101 (99 regular, 2 scan edges)
- Antenna impedance : 50Ω unbalanced (Tuner off)
- Antenna connector : SO-239×4 and BNC×2
- Power supply requirement: 85–265V AC
- Temperature range : 0°C to +50°C; +32°F to +122°F
- Frequency stability : Less than ±0.05ppm  
(0°C to +50°C, after warm up)
- Frequency resolution : 1Hz (minimum)
- Power consumption : Tx Max. power 800VA  
Rx Stand-by 200VA (typ.)  
Max. audio 210VA (typ.)
- Dimensions : 424(W)×149(H)×435(D) mm;  
(projections not included) 16<sup>1</sup>/<sub>16</sub>(W)×5<sup>7</sup>/<sub>8</sub>(H)×17<sup>1</sup>/<sub>8</sub>(D) in
- Weight (approx.) : 25kg; 55lb

### TRANSMITTER

- Output power (continuously adjustable) :  
SSB, CW, RTTY, PSK31, FM 5–200W  
AM 5–50W  
137kHz, CW\* More than –20dBm  
(\* Depending on version.)
- Modulation system :  
SSB DPSN modulation  
AM Digital low power modulation  
FM Digital phase modulation
- Spurious emission : More than 60dB (HF bands)  
More than 70dB (50MHz band)
- Carrier suppression : More than 63dB
- Unwanted sideband suppression: More than 80dB
- ΔTX variable range : ±9.999kHz
- Microphone impedance : 600Ω (8-pin connector)

### RECEIVER

- Receive system : Double conversion  
super-heterodyne system
- Intermediate frequencies :  
1st 64.455MHz (Main receiver)  
64.555MHz (Sub receiver)  
2nd 36kHz
- Sensitivity (typical) :  
SSB, CW, RTTY, PSK31, FM (BW: 2.4kHz at 10dB S/N)  
0.1–1.799MHz 0.5μV\*1  
1.8–29.999MHz 0.16μV\*1  
50.0–54.0MHz 0.13μV\*2  
AM (BW: 6kHz at 10dB S/N)  
0.1–1.799MHz 6.3μV\*1  
1.8–29.999MHz 2μV\*1  
50.0–54.0MHz 1μV\*2

FM (BW: 15kHz at 12dB SINAD)  
28–29.999MHz 0.5μV\*1  
50.0–54.0MHz 0.32μV\*2

\*1 Pre-amp 1 is ON, \*2 Pre-amp 2 is ON.

- Squelch sensitivity (Pre-amp: OFF):  
SSB, CW, RTTY, PSK31 Less than 5.6μV  
FM Less than 1μV
- Selectivity (representative value):  
SSB (BW: 2.4kHz) More than 2.4kHz/–3dB  
Less than 3.6kHz/–60dB  
More than 500Hz/–3dB  
Less than 700Hz/–60dB  
More than 360Hz/–6dB  
Less than 650Hz/–60dB  
AM (BW: 6kHz) More than 6.0kHz/–3dB  
Less than 15.0kHz/–60dB  
More than 12.0kHz/–6dB  
Less than 20.0kHz/–60dB

- Spurious and image : More than 70dB  
rejection ratio
- Audio output power : More than 2.6W at 10% distortion  
with an 8Ω load
- RIT variable range : ±9.999kHz
- PHONES connector : 3-pin connector 6.35 (d) mm (1/4")
- EXT SP connector : 2-pin connector 3.5 (d) mm  
(1/8")/8Ω

All stated specifications are subject to change without notice or obligation.

The LCD display may have cosmetic imperfections that appear as small or dark spots. This is not a malfunction or defect, but a normal characteristic of LCD displays.

## OPTIONS



**IC-PW1 HF+50MHz 1kW LINEAR AMPLIFIER**  
Covers all HF and 50MHz bands, provides clean, stable 1kW output. Automatic antenna tuner and compact detachable controller are standard. 2 exciter inputs and 4 antenna connectors are available. (Not available for EU countries.)



**SP-20 EXTERNAL SPEAKER**  
4 audio filters; headphone jack; can connect to 2 transceivers.  
Input impedance: 8Ω  
Max. input power: 5W



**SM-20 DESKTOP MICROPHONE**  
Unidirectional, electret microphone for base station operation. [UP/DOWN] switches and a low cut function are available.



**HM-36 HAND MICROPHONE**  
Hand microphone with [UP/DOWN] switches.



**CT-17 CI-V LEVEL CONVERTER**  
For remote transceiver control in the remote jack using a PC equipped with an RS-232C port.

**Icom Inc.** 1-1-32, Kamiminami, Hirano-ku, Osaka 547-0003, Japan Phone: +81 (06) 6793 5302 Fax: +81 (06) 6793 0013 URL: <http://www.icom.co.jp/world/index.html>

**Count on us!**

**Icom America Inc.**  
<Corporate Headquarters>  
2380 116th Avenue N.E., Bellevue, WA 98004, U.S.A.  
Phone: +1 (425) 454-8155 Fax: +1 (425) 454-1508  
URL : <http://www.icomamerica.com>  
<Customer Service> Phone: +1 (425) 454-7619

**Icom Canada**  
Glenwood Centre #150-6165 Highway 17,  
Delta, B.C., V4K 5B8, Canada  
Phone: +1 (604) 952-4266 Fax: +1 (604) 952-0090  
URL : <http://www.icomcanada.com>

**Icom (Australia) Pty. Ltd.**  
A.B.N. 88 006 092 575  
290-294 Albert Street, Brunswick, Victoria, 3066, Australia  
Phone: +61 (03) 9387 0666 Fax: +61 (03) 9387 0022  
URL : <http://www.icom.net.au>

**Icom New Zealand**  
146A Harris Road, East Tamaki, Auckland, New Zealand  
Phone: +64 (09) 274 4062 Fax: +64 (09) 274 4708  
URL : <http://www.icom.co.nz>

**Icom (Europe) GmbH**  
Communication Equipment  
Himmelgeister Str. 100, D-40225 Düsseldorf, Germany  
Phone: +49 (0211) 346047 Fax: +49 (0211) 333639  
URL : <http://www.icomeurope.com>

**Icom Spain S.L.**  
C/ta de Gracia a Manresa Km. 14,750  
08190 Sant Cugat del Valles Barcelona, Spain  
Phone: +34 (93) 590 26 70 Fax: +34 (93) 589 04 46  
URL : <http://www.icomspain.com>

**Icom (UK) Ltd.**  
Unit 9, Sea St., Herne Bay, Kent, CT6 8LD, U.K.  
Phone: +44 (01227) 741741 Fax: +44 (01227) 741742  
URL : <http://www.icomuk.co.uk>

**Icom France S.a**  
Zac de la Plaine, 1, Rue Brindejonn des Moulinais  
BP 5804, 31505 Toulouse Cedex, France  
Phone: +33 (5) 61 36 03 03 Fax: +33 (5) 61 36 03 00  
URL : <http://www.icom-france.com>

**Asia Icom Inc.**  
6F No. 68, Sec. 1 Cheng-Teh Road, Taipei, Taiwan, R.O.C.  
Phone: +886 (02) 2559 1899 Fax: +886 (02) 2559 1874  
URL : <http://www.asia-icom.com>

**Beijing Icom Ltd.**  
1305, Wanshang Plaza, Shijingshan Road, Beijing, China  
Phone: +86 (010) 6866 6337 Fax: +86 (010) 6866 3553  
URL : <http://www.bjicom.com>



Icom Inc. (Japan), is an ISO 9001 and ISO 14001 certification acquired company.

Your local distributor/dealer: